

Turmdrehkran

Tower Crane / Grue à tour / Gru a torre / Grúa torre /
Guindaste de torre / Кран башенный

370 EC-B 12 Fibre

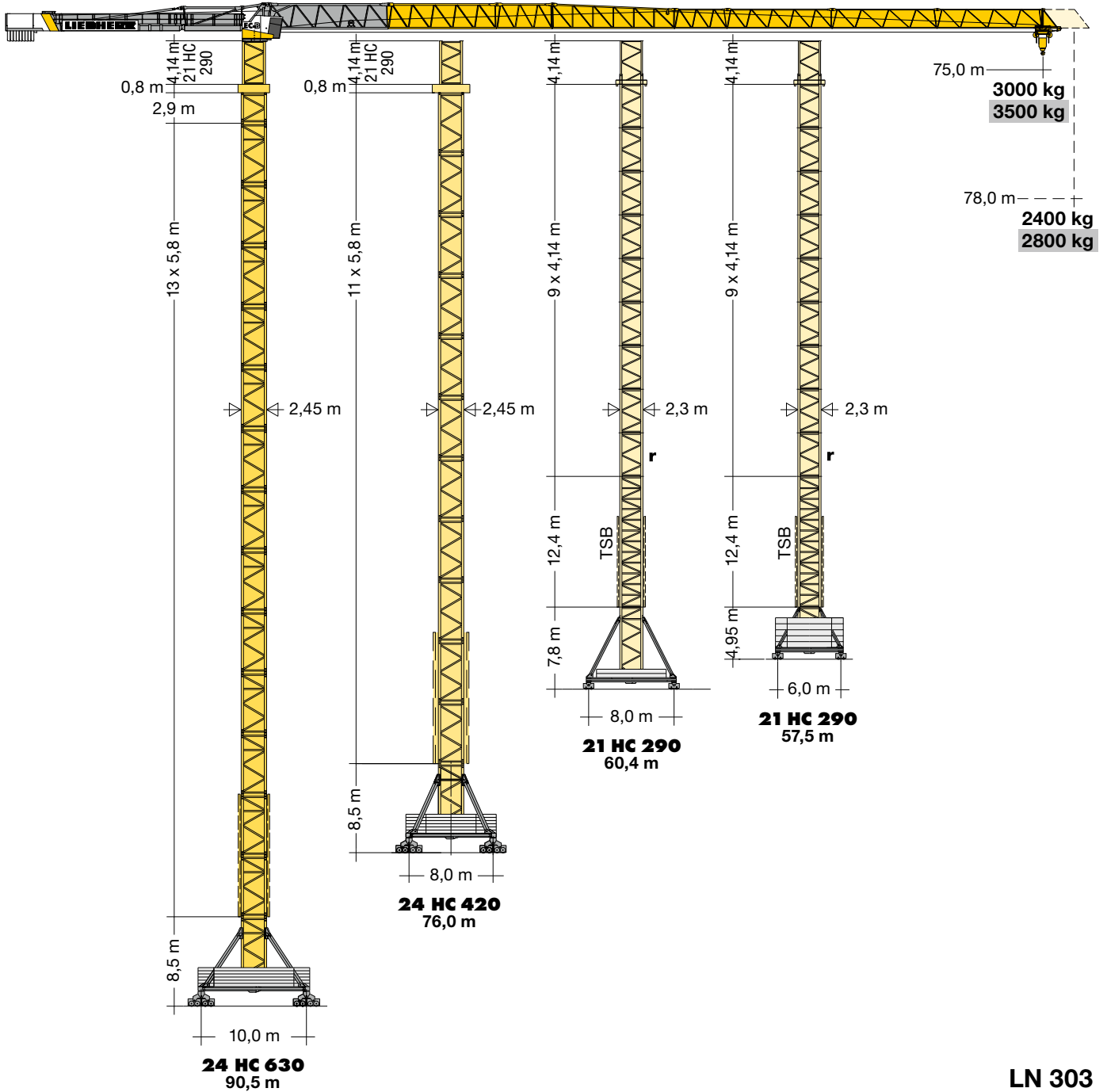

LN 303

LIEBHERR

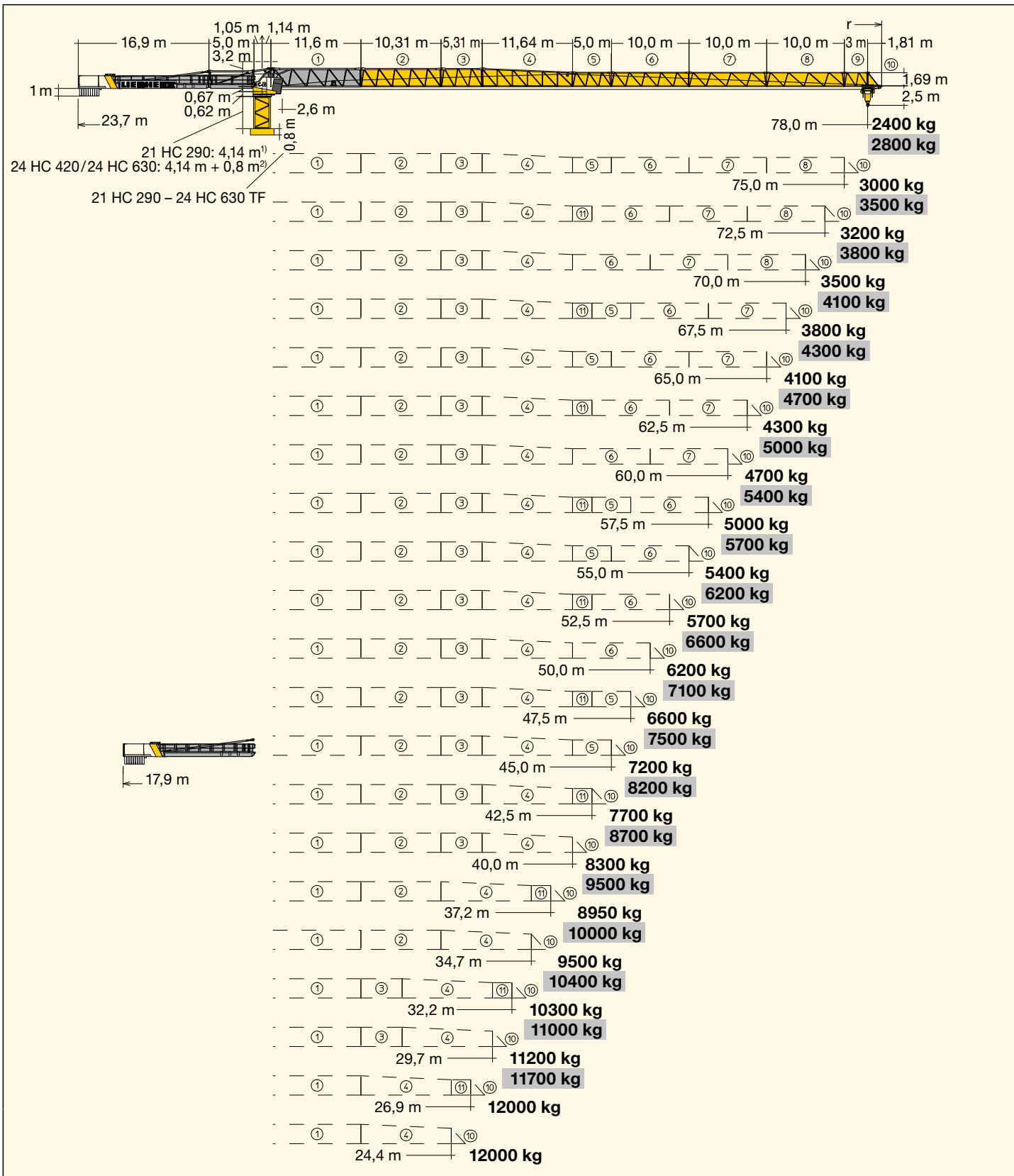

1) Turmstück oder Kletterturmstück/Tower section or climbing tower section/Élément de mât ou élément de mât télescopable/Elemento torre oppure elemento torre telescopabile/Tramo torre o tramo torre trepable/Segmento de torre ou segmento de torre para ascensão/Башенная секция или секция наращивания

2) Turmstück 21 HC 290 + Übergangsrahmen 21 HC 290 - 24 HC 630 TF/Tower section 21 HC 290 + transition frame 21 HC 290 - 24 HC 630 TF/Élément de mât 21 HC 290 + cadre de raccordement 21 HC 290 - 24 HC 630 TF/Elemento di torre 21 HC 290 + Adattatore torre 21 HC 290 - 24 HC 630 TF/Tramo torre 21 HC 290 + Marco de transición 21 HC 290 - 24 HC 630 TF/Segmento de torre 21 HC 290 + Quadro de transição 21 HC 290 - 24 HC 630 TF/Башенная секция 21 HC 290 + Переходная рама 21 HC 290 - 24 HC 630 TF

m	r	m/kg	370 EC-B 12 Fibre																					
			24,4	26,9	29,7	32,2	34,7	37,2	40,0	42,5	45,0	47,5	50,0	52,5	55,0	57,5	60,0	62,5	65,0	67,5	70,0	72,5	75,0	78,0
78,0	(r=79,6)	2,6 - 19,2 12000	9230	8290	7430	6790	6240	5770	5320	4960	4650	4370	4110	3890	3680	3490	3320	3160	3010	2870	2750	2630	2520	2400
75,0	(r=76,6)	2,6 - 22,0 12000	10720	9640	8650	7910	7290	6750	6220	5810	5450	5130	4830	4570	4330	4110	3920	3730	3560	3410	3260	3130	3000	
72,5	(r=74,1)	2,6 - 22,4 12000	10940	9840	8830	8080	7440	6890	6350	5940	5570	5240	4940	4670	4430	4210	4000	3820	3650	3490	3340	3200		
70,0	(r=71,6)	2,6 - 23,3 12000	11420	10270	9220	8440	7770	7200	6640	6210	5820	5480	5170	4890	4640	4410	4190	4000	3820	3650	3500			
67,5	(r=69,1)	2,6 - 24,1 12000	11840	10650	9560	8750	8060	7470	6890	6440	6040	5690	5370	5080	4820	4580	4360	4160	3970	3800				
65,0	(r=66,6)	2,6 - 24,7 12000	12000	10940	9830	9000	8300	7690	7100	6640	6230	5860	5530	5240	4970	4720	4500	4290	4100					
62,5	(r=64,1)	2,6 - 24,8 12000	12000	10990	9870	9030	8320	7710	7120	6650	6240	5880	5550	5250	4980	4730	4510	4300						
60,0	(r=61,6)	2,6 - 25,7 12000	12000	11420	10260	9400	8660	8020	7410	6930	6500	6120	5780	5470	5190	4930	4700							
57,5	(r=59,1)	2,6 - 26,0 12000	12000	11570	10390	9510	8770	8130	7500	7020	6590	6200	5860	5540	5260	5000								
55,0	(r=56,6)	2,6 - 26,6 12000	12000	11860	10650	9760	8990	8340	7700	7200	6760	6360	6010	5690	5400									
52,5	(r=54,1)	2,6 - 26,6 12000	12000	11860	10650	9760	9000	8340	7710	7210	6770	6370	6020	5700										
50,0	(r=51,6)	2,6 - 27,2 12000	12000	12000	10920	10020	9240	8570	7920	7410	6960	6560	6200											
47,5	(r=49,1)	2,6 - 27,2 12000	12000	12000	10940	10040	9270	8600	7960	7450	7000	6600												
45,0	(r=46,6)	2,6 - 28,0 12000	12000	12000	11270	10340	9540	8850	8190	7660	7200													
42,5	(r=44,1)	2,6 - 28,0 12000	12000	12000	11280	10360	9570	8880	8220	7700														
40,0	(r=41,6)	2,6 - 28,4 12000	12000	12000	11440	10490	9680	8980	8300															
37,2	(r=38,8)	2,6 - 28,0 12000	12000	12000	11300	10400	9620	8950																
34,7	(r=36,3)	2,6 - 28,0 12000	12000	12000	11260	10310	9500																	
32,2	(r=33,8)	2,6 - 28,0 12000	12000	12000	11250	10300																		
29,7	(r=31,3)	2,6 - 28,0 12000	12000	12000	11200																			
26,9	(r=28,5)	2,6 - 26,9 12000	12000	12000																				
24,4	(r=26,0)	2,6 - 24,4 12000	12000																					

LM 1

m	r	m/kg	370 EC-B 12 Fibre																					
			24,4	26,9	29,7	32,2	34,7	37,2	40,0	42,5	45,0	47,5	50,0	52,5	55,0	57,5	60,0	62,5	65,0	67,5	70,0	72,5	75,0	78,0
78,0	(r=79,6)	2,6 - 21,0 12000	10250	9250	8320	7630	7040	6530	6030	5640	5300	4990	4710	4450	4220	4010	3820	3650	3480	3330	3190	3060	2940	2800
75,0	(r=76,6)	2,6 - 24,0 12000	11800	10670	9630	8860	8190	7610	7040	6600	6200	5850	5530	5240	4980	4740	4520	4310	4130	3950	3790	3640	3500	
72,5	(r=74,1)	2,6 - 25,0 12000	12000	11130	10040	9230	8530	7930	7340	6880	6460	6100	5760	5460	5190	4940	4710	4500	4310	4120	3960	3800		
70,0	(r=71,6)	2,6 - 25,5 12000	12000	11370	10280	9460	8750	8140	7550	7080	6660	6290	5950	5640	5360	5110	4870	4660	4460	4270	4100			
67,5	(r=69,1)	2,6 - 25,5 12000	12000	11370	10290	9480	8780	8170	7570	7110	6690	6310	5980	5670	5390	5140	4900	4690	4490	4300				
65,0	(r=66,6)	2,6 - 26,5 12000	12000	11820	10710	9870	9150	8520	7900	7420	6980	6600	6250	5930	5640	5380	5130	4910	4700					
62,5	(r=64,1)	2,6 - 27,0 12000	12000	12000	10910	10050	9320	8670	8050	7550	7110	6720	6360	6040	5750	5480	5230	5000						
60,0	(r=61,6)	2,6 - 28,0 12000	12000	12000	11310	10410	9640	8980	8320	7810	7350	6950	6580	6240	5940	5660	5400							
57,5	(r=59,1)	2,6 - 28,0 12000	12000	12000	11310	10430	9670	9010	8360	7850	7400	6990	6620	6280	5980	5700								
55,0	(r=56,6)	2,6 - 29,0 12000	12000	12000	11720	10800	10020	9330	8660	8130	7660	7240	6860	6520	6200									
52,5	(r=54,1)	2,6 - 29,0 12000	12000	12000	11730	10830	10060	9390	8730	8210	7740	7320	6940	6600										
50,0	(r=51,6)	2,6 - 29,5 12000	12000	12000	11920	11030	10250	9570	8900	8380	7910	7480	7100											
47,5	(r=49,1)	2,6 - 29,5 12000	12000	12000	11920	11030	10260	9580	8920	8390	7920	7500												
45,0	(r=46,6)	2,6 - 30,5 12000	12000	12000	12000	11390	10600	9910	9220	8680	8200													
42,5	(r=44,1)	2,6 - 30,5 12000	12000	12000	12000	11400	10610	9920	9240	8700														
40,0	(r=41,6)	2,6 - 31,0 12000	12000	12000	12000	11600	10840	10170	9500															
37,2	(r=38,8)	2,6 - 30,0 12000	12000	12000	12000	11310	10620	10000																
34,7	(r=36,3)	2,6 - 29,0 12000	12000	12000	11780	11050	10400																	
32,2	(r=33,8)	2,6 - 29,0 12000	12000	12000	11770	11000																		
29,7	(r=31,3)	2,6 - 29,0 12000	12000	12000	11700																			
26,9	(r=28,5)	2,6 - 26,9 12000	12000	12000																				
24,4	(r=26,0)	2,6 - 24,4 12000	12000																					

Load-Plus

4,14 m		21 HC 290				
4,14 m	4,14 m + 2,07 m	LN 303				
10	9 + 1	-	57,0 ^{*)4)}	-	-	-
9	8 + 1	40,4 ^{*)}	54,9 ^{*)4)}	-	-	57,5 ^{*)3)}
8	7 + 1	38,3 ^{*)}	52,8 ^{*)3)}	-	-	55,5 ^{*)}
7	6 + 1	36,3	50,8 ^{*)}	-	-	53,4 ^{*)}
6	5 + 1	34,2	48,7 ^{*)}	-	-	51,3
5	4 + 1	32,1	46,6	69,4 ^{*)}	49,2	52,1
4	3 + 1	30,1	44,5	67,3 ^{*)}	47,2	50,0
3	2 + 1	28,0	42,5	65,3	45,1	48,0
2	1 + 1	25,9	40,4	63,2	43,0	45,9
1	0 + 1	23,8	38,3	61,1	41,0	43,8
0		21,8	36,3	59,0	38,9	41,7
		19,7	34,2	57,0	36,8	39,7
		17,6	32,1	54,9	34,8	37,6
		15,6	30,1	52,8	32,7	35,5
		13,5	28,0	50,8	30,6	33,5
		11,4	25,9	48,7	28,5	31,4
		9,4	23,9	46,6	26,5	29,3
		7,3	21,8	44,5	24,4	27,2
		5,2	19,7	42,5	22,3	25,2
		3,2	17,6	40,4	20,3	23,1
		m	m	m	m	m

5,8 m		24 HC 420		24 HC 420 / 24 HC 630	24 HC 630	
5,8 m	5,8 m + 2,9 m	LN 303				
14	13 + 1	-	-	85,3 ^{*)8)}	-	-
13	12 + 1	-	-	82,4 ^{*)7)}	94,6 ^{*)}	90,5 ^{*)}
12	11 + 1	-	-	79,5 ^{*)7)}	91,7 ^{*)}	87,6 ^{*)}
11	10 + 1	69,6 ^{*)}	76,0 ^{*)}	76,6 ^{*)6)}	88,8	84,7
10	9 + 1	66,7 ^{*)}	73,1 ^{*)}	73,7 ^{*)6)}	85,9	81,8
9	8 + 1	63,8	70,2	70,8 ^{*)5)}	83,0	78,9
8	7 + 1	60,9	67,3	67,9 ^{*)}	80,1	76,0
7	6 + 1	58,0	64,4	65,0 ^{*)}	77,2	73,1
6	5 + 1	55,1	61,5	62,1	74,3	70,2
5	4 + 1	52,2	58,6	59,2	71,4	67,3
4	3 + 1	49,3	55,7	56,3	68,5	64,4
3	2 + 1	46,4	52,8	53,4	65,6	61,5
2	1 + 1	43,5	50,0	50,5	62,7	58,6
1	0 + 1	40,6	47,1	47,6	59,8	55,7
0		37,7	44,2	44,7	56,9	52,8
		34,8	41,3	41,8	54,0	49,9
		31,9	38,4	38,9	51,1	47,0
		29,0	35,5	36,0	48,2	44,1
		26,1	32,6	33,1	45,3	41,2
		23,2	29,7	30,2	42,4	38,3
		20,3	26,8	27,3	39,5	35,4
		17,4	23,9	24,4	36,6	32,5
		14,5	21,0	21,5	33,7	29,6
		11,6	18,1	18,6	30,8	26,7
		8,7	15,2	15,7	27,9	23,8
		5,8	12,3	12,8	25,0	20,9
				9,9	22,1	18,0
				7,0	19,2	15,1
				4,1	16,3	12,2
		m	m	m	m	m

Turmstücke 24 HC 630 müssen am Turmfuß eingebaut werden. Details siehe Bedienungsanleitung. / Tower sections 24 HC 630 must be installed on the tower base. See operating manual for further details. / Les éléments de mât 24 HC 630 doivent être montés en pied de grue. Voir les détails dans les instructions d'emploi. / Elementi torre 24 HC 630 devono essere montati alla base torre. Si veda il manuale istruzioni per i dettagli. / Los tramos torre de la 24 HC 630 tienen que ser montados en el pie de torre. Más detalles en las instrucciones de montaje. / Segmentos de torre 24 HC 630 devem ser instalados sobre o segmento base. Para mais detalhes consultar manual de instrução. / Башенные секции 24 HC 630 должны монтироваться в основании башни. Подробную информацию смотри в инструкции по эксплуатации.

- *)  3) 1 x 21 HC 290 TS-0414cr
4) 2 x 21 HC 290 TS-0414cr
5) 1 x 24 HC 630 TS-0580c
6) 2 x 24 HC 630 TS-0580c
7) 3 x 24 HC 630 TS-0580c
8) 4 x 24 HC 630 TS-0580c

Weitere Hubhöhen, Auslegerlängen sowie Klettern im Gebäude auf Anfrage. / Further hoist heights and jib lengths as well as climbing inside the building on request. / Autres hauteurs sous crochet et longueurs de flèche ainsi que hissage dans le bâtiment sur demande. / Ulteriori altezze gancio, lunghezze braccio così come telescopaggio all'interno dell'edificio: su richiesta. / Para alturas bajo gancho superiores, otros alcances y trepado en el interior del edificio, consultar. / Outras alturas de elevação, comprimentos de lança e subida no edifício: sob consulta. / Другие высоты подъема, длины стрелы и самоподъем в здании – по запросу.

r = verstärkt / reinforced / renforcé / rinforzato / reforzado / reforçado / усиленный

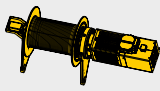
	↔ stufenlos / stepless / régl. continu / regl. progressiva / sin escalones / sem degraus / бесступенчатый kg m/min
45 kW FU FSW 260 MZ 004 5 Lagen Layers Couches Avvolgimenti Camadas Capas Слоёв 182,0 m max. 269,0 m ⁹⁾	1 12000 0 ↔ 20 1100 0 ↔ 119

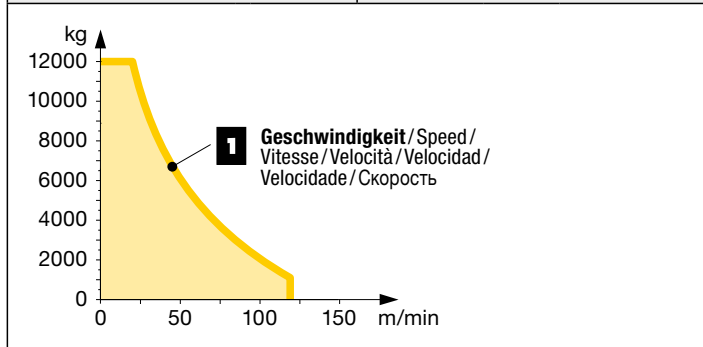

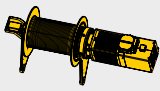
	↔ stufenlos / stepless / régl. continu / regl. progressiva / sin escalones / sem degraus / бесступенчатый kg m/min
65 kW FU FSW 280 MZ 001 5 Lagen Layers Couches Avvolgimenti Camadas Capas Слоёв 182,0 m max. 269,0 m ⁹⁾	1 12000 0 ↔ 29 2300 0 ↔ 119

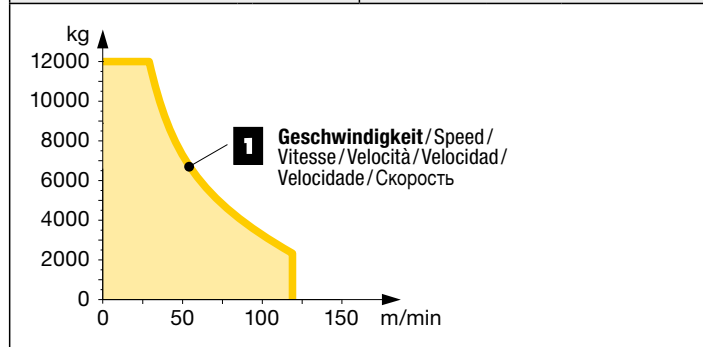

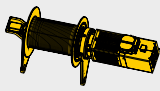
	↔ stufenlos / stepless / régl. continu / regl. progressiva / sin escalones / sem degraus / бесступенчатый kg m/min
110 kW FU SD.shift FSW 300 WZ 001 5 Lagen Layers Couches Avvolgimenti Camadas Capas Слоёв 182,0 m max. 269,0 m ⁹⁾	1 12000 0 ↔ 49 3200 0 ↔ 160 2 5600 0 ↔ 100 1700 0 ↔ 272

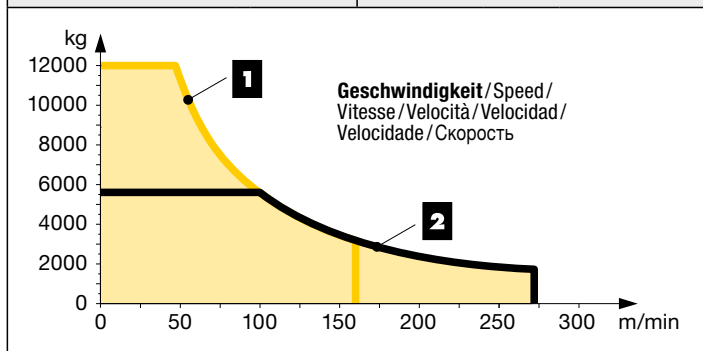

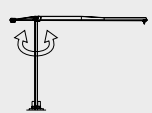
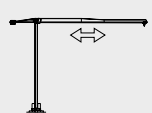
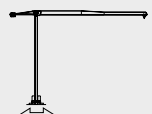

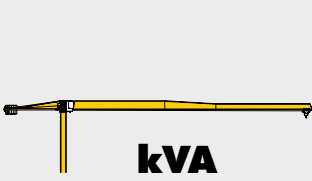

























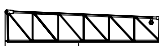

























	0 ↔ 0,7 U/min sl./min tr./min	2 x 7,5 kW FU
	0 ↔ 109,0 m/min	7,5 kW FU
	25,0 m/min	2 x 7,5 kW (21 HC 290) 4 x 7,5 kW (24 HC 420/ 24 HC 630)

	kVA	45 kW FU 65,0	65 kW FU 86,0	110 kW FU 122,0
--	------------	------------------	------------------	--------------------



⁹⁾ Weitere Hublastdaten: siehe Betriebsanleitung. / Further hoist load data: see instruction manual. / Autres données de la charge de levage : voir manuel d'instruction. / Altri dati sui carichi sollevati: consultare il manuale d'istruzione. / Alturas bajo granco superiores según manual. / Outras tabelas de carga: consultar manual de instruções. / Другие данные по весу поднимаемых грузов: см. инструкцию по эксплуатации.

kVA reduzierbar bei zu geringer Netz-Anschlussleistung, siehe BAL. / kVA can be reduced in case of too little power of the mains, see instruction manual. / kVA peut être réduit en cas de trop faible puissance du réseau, voir manuel d'instruction. / kVA riducibili in caso di potenza di rete ridotta (si veda manuale uso e manutenzione) / kVA variable para potencia de red demasiado pequeña, ver Manual de instrucciones. / kVA reduzível no caso de capacidade da rede elétrica muito baixa, ver manual de instruções. / Количество кВА может быть сокращено до минимальной общей потребляемой мощности, см. инструкцию по эксплуатации.

Kranoberteil		Upper part of crane / Partie supérieure de grue / Parte superiore della gru / Parte superior grúa / Parte superior do guindaste / Верхняя часть крана	L (m)	B (m)	H (m)	kg ⁽¹⁰⁾		
Pos. Item Rep Voce Pos. Ref. Поз.	Anz. Qty. Qte. Qta. Cant. Cant. Кол-во	Drehbühne kpl. mit Kugeldrehkranz und KUD-Auflage 21 HC 290 mit Klappspitze, Kabine und Schaltschrank mit Podesten / Slewing platform complete with slewing ring and slewing ring support 21 HC 290 with folding head, cabin and switch cabinet with platforms / Plate-forme tournante complète avec couronne d'orientation et pivot d'orientation 21 HC 290 avec pointe pliante, cabine et armoire électrique avec plates-formes / Piattaforma girevole con ralla e supporto ralla 21 HC 290 con punta ribaltabile, cabina e quadro elettrico con pedane / Plataforma giratoria completa con corona de rotación y asiento de pista 21 HC 290 con punta abatible y armario eléctrico con plataforma / Plataforma de giro completa com coroa de giro e assento da coroa 21HC 290, com cavalete dobrável, cabine e painel elétrico com plataformas / Поворотная платформа в сб. с шариковым поворот- ным кругом и рамой ОПУ 21 HC 290 с откидным кронштейном, кабиной и распределительным электрошкафом с площадками			6,57	2,42	2,55	11800
1	1							
1a	1	Drehbühne mit Kugeldrehkranz und KUD-Auflage 21 HC 290 / Slewing platform with slewing ring and slewing ring support 21 HC 290 / Plate-forme tournante avec couronne d'orientation et pivot d'orientation 21 HC 290 / Piattaforma girevole con ralla e supporto ralla 21 HC 290 / Plataforma giratoria con corona de rotación y asiento de pista 21 HC 290 / Plataforma de giro com coroa de giro e assento da coroa 21 HC 290 / Поворотная платформа с шариковым поворотным кругом и рамой ОПУ 21 HC 290			3,67	2,39	2,45	7050
1b	1	Schaltschrank mit Podest / Switch cabinet with platform / Armoire électrique avec plate-forme / Quadro elettrico con pedana / Armario eléctrico con plataforma / Armário elétrico com plataforma / Электрошкаф с площадкой			2,31	2,19	1,95	1550
1c	1	Kabine mit Podest / Cabin with platform / Cabine avec plate-forme / Cabina con pedana / Cabina con plataforma / Cabina com plataforma / Кабина с площадкой			2,40	2,09	2,47	1700
1d	1	Klappspitze / Folding head / Pointe pliante / Punta ribaltabile / Pluma / Cavalete dobrável / Откидной кронштейн			1,86	1,45	2,34	1500
2	1	Gegenausleger lang / Counter-jib, long / Contre-flèche longue / Controffrecia lunga / Contrapluma larga / Contra-lança, longa / Консоль противовеса, длинная			11,89	2,33	3,01	16100
2a	1	Gegenausleger kurz / Counter-jib, short / Contre-flèche courte / Controffrecia corta / Contrapluma corta / Contra-lança, curta / Консоль противовеса, короткая			11,89	2,33	2,67	12600
2b	1	Gegenausleger-Zwischenstück / Intermediate counter-jib section / Elément interm. de contre-flèche / Spezzone di controbraccio / Tramo intermedio de contrapluma / Peça suplementar da contra- lança / Промежуточная секция консоли противовеса			6,26	1,85	2,45	3500
3	1	Ausleger-Anlenkstück / Jib heel section / Pied de flèche / Sezione articolata braccio / Pluma tramo primero / Base articulada de lança / Корневая секция стрелы			11,92	1,28	2,53	① 5300
4	1	Ausleger-Zwischenstück / Intermediate jib section / Elément intermédiaire de flèche / Sezione intermedia braccio / Tramo intermedio pluma / Peça suplementar da lança / Промежуточная секция стрелы			10,65 5,64	1,28 1,28	2,48 2,47	② 2700 ③ 1150
5	1	Ausleger-Zwischenstück / Intermediate jib section / Elément intermédiaire de flèche / Sezione intermedia braccio / Tramo intermedio pluma / Peça suplementar da lança / Промежуточная секция стрелы			11,94	1,28	2,45	④ 2050
6	1	Ausleger-Zwischenstück / Intermediate jib section Elément intermédiaire de flèche / Sezione intermedia braccio / Tramo intermedio pluma / Peça suplementar da lança / Промежуточная секция стрелы			5,28 10,25 10,23 10,22 3,22 2,78	1,28 1,28 1,28 1,28 1,28 1,28	1,95 1,95 1,94 1,93 1,93 1,95	⑤ 760 ⑥ 1280 ⑦ 850 ⑧ 660 ⑨ 240 ⑩ 460
7	1	Ausleger-Kopfstück / Jib head section / Pointe de flèche / Punta braccio / Tramo punta de pluma / Cabeça de lança / Концевая секция стрелы			1,91	1,28	2,12	⑪ 260
8	1	Laufkatze und Lsthaken / Trolley and hook / Chariot de distribution et crochet / Carrello con gancio / Carrito y gancho / Carro de ponte e gancho / Грузовая тележка и грузовой крюк			2,06	1,62	1,71	565
9	1	Fahrkorb / Maintenance cage / Nacelle d'entretien / Cestello di manutenzione / Plataforma de mantenimiento / Передвижная платформа			0,66	0,57	1,17	25

Pos. Item Rep. Voce Pos. Ref. Поз.	Anz. Qty. Qte. Qta. Cant. Cant. Кол-во				L (m)	B (m)	H (m)	kg ⁽¹⁰⁾	
Turm		Tower / Mât / Torre Torre / Torre / Башня							
10	1	Turmstück / Tower section / Élément de mât / Elemento di torre / Tramo torre / Torre / Башенная секция			21 HC 290 TS-0414c 21 HC 290 TS-0414cr 21 HC 290 TS-1242c 24 HC 420 TS-0290c 24 HC 420 TS-0580c 24 HC 420 TS-1160 24 HC 630 TS-0290c 24 HC 630 TS-0580c 24 HC 630 TS-1160	4,14 4,14 12,42 3,19 6,09 11,90 3,38 6,28 12,10	2,30 2,30 2,30 2,45 2,45 2,45 2,45 2,45 2,45	2,30 2,30 2,30 2,45 2,45 2,45 2,45 2,45 2,45	2500 2950 6100 2950 4500 7200 4050 6450 10750
11	1	Grundturmstück / Base tower section / Mât de base / Elemento di torre base / Tramo base / Peça de base de torre / Секция основания			21 HC 290 TSB-1242c 24 HC 630 TSB-1242c 24 HC 630 TSB-1242r	12,42 12,42 12,42	2,30 2,68 2,68	2,30 2,68 2,68	8200 14500 17300
12	1	Kletterturmstück / Climbing tower section / Élément de hissage de mât / Elemento torre di telescopaggio / Tramo de trepado / Tramo de telescopagem / Секция самоподъема			21 HC 290 ECTS-0414	4,14	2,30	2,45	3300
13	1	Übergangsrahmen / Transition frame / Cadre de raccordement / Adattatore torre / Chasis de unión / Quadro adaptador / Переходная рама			21 HC 290 – 24 HC 630 TF-0080	3,16	2,85	1,08	3700
Klettereinrichtung		Climbing equipment / Equipement de télescopage / Attrezzatura per allungamento della gru / Equipo de trepado / Acsórios p. subida no edificio / Обойма наращивания							
14	1	Führungsstück kpl., geteilt / Guide section cpl., split / Cage télescopique cpl., devisée / Gabbia de sopraelevazione compl., suddivisa / Torre de montaje completa, dividida / Peça de guia compl., subdividida / Направляющая секция в сб., разъемная			21 HC 290 ECGS 24 HC 630 ECGS	8,39 12,39	2,75 2,78	2,70 (3,04) 1,58	5800 8550
15	1	Hydraulikanlage, Stütz- und Klettertraverse / Hydraulic unit, supporting and climbing crossmembers / Système hydraul. avec traverses d'appui et de télescop. / Sist. idraul., traversa di appoggio e allugam. gru / Sistema hidráulico con traviesa de apoyo y trepado / Instalação hidráulica, travessa de apoio e subida / Гидроагрегат, стойка-упор и траверса обоймы наращивания			21 HC 290 24 HC 630	2,10 2,60	1,25 1,50	1,00 1,00	1150 1900
Unterwagen		Undercarriage / Châssis / Carro / Carro con mástil / Carro de guindaste / Опорная рама							
16	4	Ausgleichsschwinge mit Schwingenlager / Pivot for wheel box / Chape pour bogie / Bilanciere di equilibratura con cuscinetto bilanciere / Balancin / Balancim com suporte / Балансир с шарнирной опорой			24 HC 630	1,60	0,72	1,48	1470
17	2	Fahrschemel mit Antrieb / Rail bogie with drive / Bogie moteur / Telaio con gruppo propulsore / Caja rodillo motoriz / Quadra sem grupa de propulsão / Подрамник с приводом			21 HC 290 24 HC 630	1,63 (1,46) 1,45	0,92 (0,84) 0,82	0,95 (0,87) 0,72	1690 (920) 1200
18	2	Fahrschemel ohne Antrieb / Rail bogie without drive / Bogie fou / Telaio senza gruppo propulsore / Caja rodillo conducido / Quadra com grupa de propulsão / Подрамник без привода			21 HC 290 24 HC 630	1,37 (1,15) 1,30	0,62 (0,60) 0,40	0,95 (0,87) 0,72	1340 (880) 950
19	2	Tragholm lang / Long support arm / Longeron long / Longherone lungo / Brazo soporte largo / Travessa comprida / Несущая балка, длинная			21 HC 290 24 HC 630	9,10 (11,95) 7,32 (5,91)	0,80 (0,82) 0,92 (0,92)	0,80 (0,80) 0,93 (0,93)	1650 (2200) 2330 (1980)
20	2	Tragholm kurz / Short support arm / Longeron court / Longherone corto / Brazo soporte corto / Travessa curta / Несущая балка, короткая			21 HC 290 24 HC 630	4,45 (5,58) 7,14 (5,73)	0,77 (0,65) 0,92 (0,80)	0,77 (0,77) 0,90 (0,90)	800 (1040) 2180 (1780)
21	2+2	Randträger / Border support / Traverse / Supporti base Traviesas / Apoio de bordo / Стяжная балка			21 HC 290 24 HC 630	5,46 – 5,40 (7,52 – 7,46) 9,30 (7,30)	0,11 – 0,18 (0,10 – 0,17) 0,24 (0,14)	0,16 – 0,38 (0,10 – 0,38) 0,41 (0,14)	175 – 525 (370 – 915) 870 (400)
22	4	Stützholm / Support strut / Hauban de châssis / Correnti di appoggio / Tirante vertical / Travessa de apoio / Опорный подкос			21 HC 290 24 HC 630	4,14 (6,55) 6,98 (6,05)	0,18 (0,22) 0,26 (0,26)	0,25 (0,25) 0,39 (0,39)	320 (600) 1190 (1140)
23	1	Unterwagen-Turmstück / Undercarriage tower section / Mât de châssis / Elemento di torre del carro / Tramo de carro / Peça de torre do chassis / Опорная башенная секция			21 HC 290 24 HC 630	3,73 (6,70) 6,61	2,62 (2,53) 2,44	2,62 (2,53) 2,44	2920 (4030) 7930
24		Kleinteile, Seile und Abspannungen / Small parts, ropes and holding bars / Accessoires, câbles et tirants / Accessori, funi e attrezzi di ancoraggio / Despieces, cables y tirantes / Acsórios, cabos e peças de ancoragem / Мелкие детали, Канаты и Пристежки			21 HC 290 24 HC 630	9,00	1,60	1,00	4000

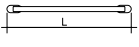
Pos. Anz.
Item Qty.
Rep. Qte.
Voce Qta.
Pos. Cant.
Ref. Cant.
Поз. Кол-во

				L (m)	B (m)	H (m)	kg ¹⁰⁾	
Fundamentkreuz		Cruciform base/Châssis en croix/Crociera/Carro de guindaste/Base cruciforme/Фундаментная крестовина						
25	2	Hauptträger / Main beam / Poutre principale / Traversa portante / Viga principal / Travessa comprida / основная балка		24 HC 420 CB-0600	9,20	1,10	1,53	8300
26	2	Randträger / Border support / Traverse / Supporti base / Traviesa / Apoio de bordo / Стяжная балка		24 HC 420 CB-0600	5,50	0,25	0,66	560
27	4	Adapter HC-Turm / Adapter for HC tower / Adaptateur pour mât HC / Adattatore torre HC / Tramo transición HC / Adaptador para torre HC / Переходной элемент башни HC		24 HC 420 CB-0600	0,43	0,43	0,64	320

() **Angaben in Klammern gelten für 8 m-Unterwagen.** / The data in brackets are valid for an undercarriage of 8 m. / Les données techniques indiquées entre parenthèses sont valables pour un châssis de 8 m. / Caratteristiche in (..) valgono per carro di 8 m. / Los datos entre paréntesis son válidos para carro de 8 m. / Características em (..) válidas pelo chassis de 8 m. / Данные в скобках относятся к 8-метровой опорной раме.

¹⁰⁾ **Einzelgewichte** / Single weights / Poids individuels / Singoli pesi / Tramo punta de pluma / Pesos de peças componentes / Индивидуальный вес

Änderungen vorbehalten! / Subject to technical modifications! /
Sous réserves de modifications ! / Con riserva di modifiche! /
¡Sujeto a modificaciones sin previo aviso! / Sujeto a modificaciones! /
С правом внесения изменений!

Sämtliche Angaben erfolgen ohne Gewähr. / This information is supplied without liability. /
Ces renseignements sont sans garantie. / Tutte le indicazioni fornite senza garanzia. /
Declinamos toda responsabilidad derivada de la información proporcionada. / Declinamos
qualquer responsabilidade quanto à informação fornecida. / Все данные указаны без обязательств.

TCS-002378-LBC-01 • EN 14439:2009 – A3 • BGL C.0.10.0355 • 04.20

Printed in Germany.

Liebherr-Werk Biberach GmbH
Postfach 1663, D-88396 Biberach an der Riss
☎ +49 73 51 41-0, Fax: +49 73 51 41 22 25
www.liebherr.com, E-Mail: info.lbc@liebherr.com

Liebherr Industrias Metálicas, S.A.
Polígono Industrial Agustinos, calle E, E-31014 Pamplona
☎ +34 94829 70-00, Fax +34 94829 70-29
www.liebherr.com, E-Mail: info.lim@liebherr.com